

DOUBLE SCISSOR LIFT

3.5 T ELECTRO-HYDRAULIC

The low-profile double scissor lift DS35EXHG has been specially designed for the service and repair sector. The EX version even allows safe mounting of VW T5 / T6, Mercedes

V-Class and Opel Movano (short wheelbases) as well as long luxury sedans such as BMW 7 Series G12.

+ Mounting adjustable up to 2.350 mm
+ Best corrosion protection as standard
+ Very robust steel construction

The standard-equipped CE-stop guarantees foot protection without foot deflector. This also enables underfloor installation.

The low headroom makes it easier to pick up vehicles with low ground clearance.

The construction convinces by highest stability. They're made from solid scissors.

An emergency lowering is easily possible in the event of a power failure.

All hydraulic cylinders are screwable. This increases service-friendliness.

The fully hydraulic system with integrated self-venting ensures reliable operation even in dirty environments.

Ramps standing on the ground protect the hydraulic lines and enable safe access.



HIGHLIGHTS IN DETAIL

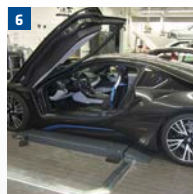
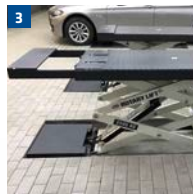
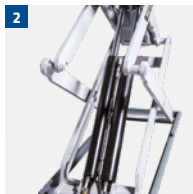

1 Longevity in the field of rust protection is also a top priority – among other things due to the standard hot-dip galvanizing with additional powder coating of the platform and base frame.

2 The redundant double master-slave hydraulic system makes it possible to dispense additional safety catches. Double safety, which prevents lifting or lowering on one side.

3 Easy operation of the pull-out is possible with floor-level installation.

4 The smart design allows easy handling of the pull-out, even when the vehicle is above.

5 Easy surface mounting is possible since the platform has a low clearance height.

6 The included rubber pads reliably protect the vehicle's underbody.

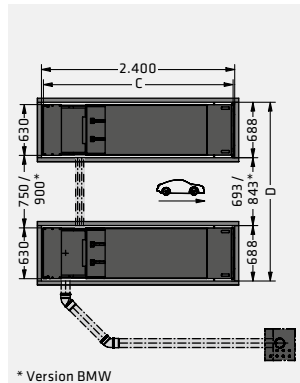
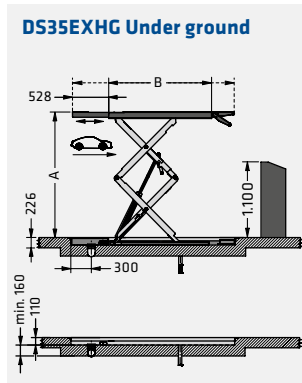
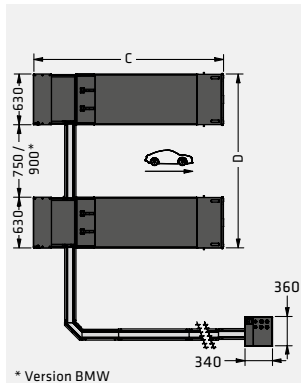
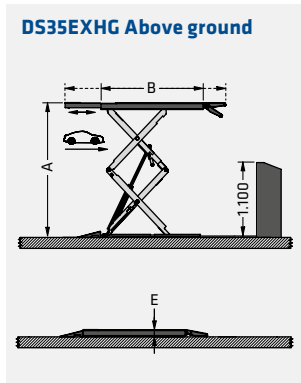

Cleanly arranged and robust push buttons ensure safe operation of the lifting platform.

Documents or tablet computers can be stored on the integrated tray system. Also perfect as a desk pad.

The pre-assembled control panel has a quiet running hydraulic unit and thus contributes significantly to a low installation effort.

Service friendliness comes first: the side panels can be removed on all 4 sides, the electrical components are located underneath the hinged operating and writing console.

The tubing can be placed to the left or right, the tubing length between lifting platform and console is 6 m.

Model	DS35EXHG
Rated load capacity	3.500 kg
A Stroke	1.940 mm
B Platform length	1.500-2.358 mm
C Total length	2.358 mm
D Overall width	2.060 / 2.160* mm
Lifting time loaded	40 s
Lowering time loaded	40 s
E Ascending height / Rest height	105 mm
Engine power	3 kW
Power supply voltage (electrical)	230 / 400 V, 50 Hz
Weight	885 kg

* Version BMW

ACCESSORIES

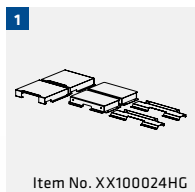

- 1 Installation kit for underfloor installation without angle iron frame
- 2 Installation kit for underfloor installation, hot-dip galvanized with angled iron frame
- 3 Additional ramps for sports cars, hot galvanized and powdercoated, length 860 mm (1 set / 4 pieces)
- 4 Crossbar for supporting vehicles whose mounting points are located in the intermediate area of the platforms
- 5 Rotary Rubber Block, pyramidal truncated with grip pads, height 30 mm (1 set / 4 pieces)
- 6 Rotary Rubber Block pyramidal truncated with grip pads, height 70 mm (1 set / 4 pieces)
- 7 Power Kit (230 V socket outlet)